

Koło łańcuchowe bez piasty 5 x 2.5 mm (03-1)

dla łańcucha rolkowego DIN 8187/ ISO R606

Materiał

Stal Fe 50

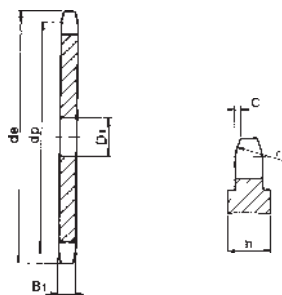

1-rzędowe

Kod	Ilość zębów z	de	dp	D1	Kod	Ilość zębów z	de	dp	D1
Na zapytanie	8	14.8	13.06	4	Na zapytanie	40	65.5	63.73	8
	9	16.4	14.62	4		42	68.7	66.91	8
	10	17.9	16.18	4		44	71.8	70.09	8
	11	19.5	17.75	5		45	73.4	71.68	8
	12	21.1	19.32	5		46	75.0	73.27	8
	13	22.6	20.89	5		48	78.2	76.45	8
	14	24.2	22.47	5		50	81.4	79.63	8
	15	25.8	24.04	5		52	84.6	82.81	10
	16	27.4	25.63	6		54	87.7	85.97	10
	17	29.0	27.20	6		55	89.3	87.58	10
	18	30.5	28.79	6		56	90.9	89.17	10
	19	32.1	30.38	6		57	92.6	90.76	10
	20	33.7	31.96	6		58	94.1	92.35	10
	21	35.3	33.54	8		60	97.3	95.53	10
	22	36.9	35.13	8		62	100.5	98.72	12
	23	38.5	36.72	8		65	105.2	103.49	12
	24	40.1	38.30	8		66	106.8	105.08	12
	25	41.6	39.89	8		70	113.2	111.44	12
	26	43.2	41.48	8		75	121.2	119.40	12
	27	44.8	43.07	8		76	122.7	120.99	12
	28	46.4	44.65	8		80	129.1	127.35	12
	30	49.6	47.83	8		85	137.1	135.31	14
	32	52.8	51.01	8		90	145.0	143.27	14
	33	54.4	52.60	8		95	153.0	151.22	14
	34	55.9	54.19	8		100	160.9	159.18	14
	35	57.5	55.78	8		110	176.8	175.09	14
	36	59.1	57.37	8		114	183.2	181.46	14
	37	60.7	58.96	8		120	192.8	191.01	14
	38	62.3	60.54	8		125	200.7	198.96	14

B1	r3	c	h
2.3	5	0.4	z≥51=4

Rozmiary w mm.

Koło łańcuchowe bez piasty 6 x 2.8 mm (04-1)

dla łańcucha rolkowego DIN 8187/ ISO R606

Materiał

Stal Fe 50

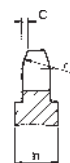
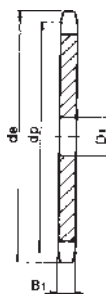

1-rzędowe

Kod	Ilość zębów z	de	dp	D1	Kod	Ilość zębów z	de	dp	D1
T 14139	8	18.0	15.67	5	T 14168	37	73.1	70.75	10
T 14140	9	19.9	17.54	5	T 14169	38	75.0	72.66	10
T 14141	10	21.7	19.42	6	T 14171	40	78.9	76.47	10
T 14142	11	23.6	21.30	6	T 14173	42	82.7	80.28	12
T 14143	12	25.4	23.18	6	T 14176	45	88.5	86.01	12
T 14144	13	27.3	25.05	8	T 14179	48	94.2	91.74	12
T 14145	14	29.2	26.96	8	T 14181	50	98.0	95.55	12
T 14146	15	31.1	28.86	8	T 14183	52	101.8	99.37	12
T 14147	16	33.0	30.76	8	T 14185	54	105.6	103.17	12
T 14148	17	35.0	32.65	8	T 14186	55	107.6	105.08	12
T 14149	18	36.9	34.55	8	T 14187	56	109.5	107.00	12
T 14150	19	38.8	36.44	8	T 14188	57	111.4	108.93	12
T 14151	20	40.7	38.44	8	T 14189	58	113.3	110.82	12
T 14152	21	42.6	40.25	8	T 14191	60	117.1	114.62	12
T 14153	22	44.5	42.16	8	T 14192	62	120.9	118.45	16
T 14154	23	46.4	44.06	8	T 14194	64	124.7	122.27	16
T 14155	24	48.3	45.96	8	T 14195	65	126.6	124.18	16
T 14156	25	50.2	47.87	8	T 14196	66	128.5	126.09	16
T 14157	26	52.1	49.77	8	T 14198	70	136.2	133.73	16
T 14158	27	54.0	51.67	8	T 14201	76	147.6	145.19	16
T 14159	28	55.9	53.58	8	T 14202	80	155.3	152.82	16
T 14161	30	59.8	57.42	8	T 65037	85	164.8	162.37	16
T 14163	32	63.6	61.21	10	T 65038	90	174.4	171.92	16
T 14164	33	65.5	63.11	10	T 14203	95	183.9	181.47	16
T 14165	34	67.4	65.02	10	T 14204	100	193.5	191.01	16
T 14166	35	69.3	66.93	10	T 14206	120	231.7	229.20	16
T 14167	36	71.2	68.84	10	T 14207	125	241.2	238.75	16

B1	r3	c	h
2.6	6	0.6	$z \geq 51 = 4$

Rozmiary w mm.

Koło łańcuchowe bez piasty 8 x 3 mm (05B-1) dla łańcucha rolkowego DIN 8187/ ISO R606

Materiał

Stal Fe 50

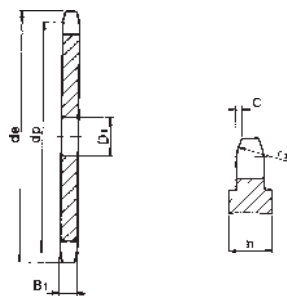

1-rzędowe

Kod	Ilość zębów z	de	dp	D1	Kod	Ilość zębów z	de	dp	D1
T 14208	8	23.4	20.90	6	T 14237	37	97.7	94.33	12
T 14209	9	25.9	23.39	6	T 14238	38	100.2	96.88	12
T 14210	10	28.4	25.89	8	T 14239	39	102.7	99.42	12
T 14211	11	31.0	28.39	8	T 14240	40	105.2	101.97	12
T 14212	12	33.7	30.91	8	T 14242	42	111.0	107.05	12
T 14213	13	36.7	33.42	8	T 14244	44	116.1	112.14	12
T 14214	14	39.2	35.95	8	T 14245	45	118.6	114.69	12
T 14215	15	41.7	38.48	8	T 14264	46	121.2	117.23	12
T 14216	16	44.2	41.01	8	T 14266	48	126.4	122.32	12
T 14217	17	46.7	43.53	8	T 14268	50	131.5	127.41	12
T 14218	18	49.2	46.07	8	T 14270	52	136.6	132.49	16
T 14219	19	51.7	48.61	8	T 14272	54	141.7	137.59	16
T 14220	20	54.2	51.14	8	T 14273	55	144.2	140.13	16
T 14221	21	57.2	53.67	10	T 14275	57	149.3	145.22	16
T 14222	22	59.4	56.21	10	T 14276	58	151.9	147.77	16
T 14223	23	62.2	58.75	10	T 14278	60	157.1	152.85	16
T 14224	24	64.7	61.29	10	T 14279	62	162.2	157.95	16
T 14225	25	67.2	63.83	10	T 14281	64	167.3	163.04	16
T 14226	26	69.7	66.37	10	T 14282	65	169.8	165.58	16
T 14227	27	72.3	68.91	10	T 14285	70	182.6	178.31	16
T 14228	28	74.7	71.45	10	T 14287	75	195.3	191.04	20
T 14229	29	77.2	73.99	10	T 14288	76	197.9	193.59	20
T 14230	30	80.2	76.53	10	T 14289	80	208.1	203.77	20
T 14231	31	82.7	79.08	10	T 65039	85	220.8	216.50	20
T 14232	32	85.2	81.61	10	T 65040	90	233.6	229.23	20
T 14233	33	87.7	84.16	10	T 14290	95	246.3	241.96	20
T 14234	34	90.2	86.70	10	T 14292	114	294.8	290.33	20
T 14235	35	92.7	89.24	10	T 14293	120	310.1	305.61	20
T 14236	36	95.2	91.79	10	T 14294	125	322.8	318.34	20

B1	r3	c	h
2.8	8	0.8	$z \geq 46 = 4$

Rozmiary w mm.

Koło łańcuchowe bez piasty 3/8" x 7/32" (06B -1 -2 -3) dla łańcucha rolkowego DIN 8187/ ISO R606

Materiał

Stal C 43

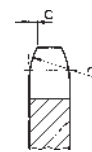
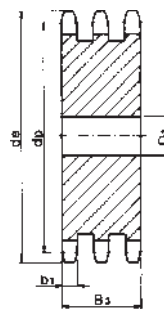
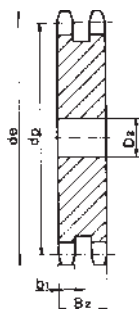
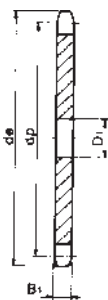

1-rzędowe	2-rzędowe	3-rzędowe	Ilość zębów z	de	dp	1-rzędowe	2-rzędowe	3-rzędowe
Kod	Kod	Kod				D1	D2	D3
T 13071	-	T 14504	8	28.6	24.89	6	-	8
T 09579	-	T 65042	9	31.5	27.85	8	-	8
T 08514	-	-	10	34.5	30.82	8	-	-
T 13072	T 14298	T 14507	11	37.5	33.80	8	10	12
T 08515	T 14299	T 14508	12	40.5	36.80	8	10	12
T 11735	T 14300	T 14509	13	43.5	39.80	8	10	12
T 08516	T 14301	T 14510	14	46.5	42.80	8	10	12
T 13073	T 14302	T 14511	15	49.5	45.81	8	10	12
T 13074	T 14303	T 14512	16	52.5	48.82	10	12	12
T 08517	T 14304	T 14513	17	55.5	51.83	10	12	12
T 13075	T 14305	T 14514	18	58.6	54.85	10	12	12
T 13076	T 14306	T 14515	19	61.6	57.87	10	12	12
T 08518	T 14307	T 14516	20	64.6	60.89	10	12	12
T 13077	T 14308	T 14517	21	67.6	63.91	10	12	16
T 13078	T 14309	T 14518	22	70.6	66.93	10	12	16
T 13079	T 14310	T 14519	23	73.7	69.95	10	12	16
T 08519	T 14311	T 14520	24	76.7	72.97	10	12	16
T 13080	T 14312	T 14521	25	79.7	76.00	10	12	16
T 13081	T 14313	T 14522	26	82.7	79.02	10	16	16
T 08520	T 14314	T 14523	27	85.7	82.04	10	16	16
T 13082	T 14315	T 14524	28	88.8	85.07	10	16	16
T 13083	T 14316	T 14525	29	91.8	88.09	10	16	16
T 13084	T 14317	T 14526	30	94.8	91.12	10	16	16
T 08521	T 14318	T 14527	31	97.9	94.15	12	16	16
T 13085	T 14319	T 14528	32	100.9	97.17	12	16	16
T 13086	T 14320	-	33	103.9	100.20	12	16	-
T 13087	T 14321	T 14530	34	106.9	103.23	12	16	16
T 13088	T 14322	T 14531	35	110.0	106.26	12	16	16
T 13089	T 14323	T 14532	36	113.0	109.29	12	16	20
T 13090	T 14324	-	37	116.0	112.32	12	16	-
T 13091	T 14325	T 14534	38	119.0	115.34	12	16	20
T 13092	T 65041	-	39	122.1	118.37	12	16	-
T 13093	T 14327	T 14536	40	125.1	121.40	12	16	20
T 13094	T 14328	-	41	129.0	124.43	16	20	-
T 13095	T 14329	T 14538	42	132.1	127.46	16	20	20
T 13096	T 14330	-	43	135.1	130.49	16	20	-

B1	B2	B3	r3	c	b1
5.3	15.4	25.6	10	1	5.2

Rozmiary w mm.

Koło łańcuchowe bez piasty 3/8" x 7/32" (06B -1 -2 -3) dla łańcucha rolkowego DIN 8187/ ISO R606

Materiał

Stal C 43

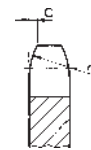
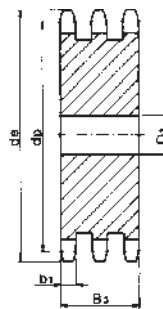
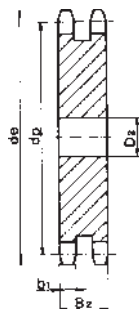
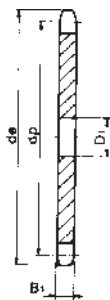

1-rzędowe	2-rzędowe	3-rzędowe	Ilość zębów z	de	dp	1-rzędowe	2-rzędowe	3-rzędowe
Kod	Kod	Kod				D1	D2	D3
T 13097	T 65043	T 14579	44	138.1	133.52	16	20	20
T 13098	T 14332	T 14580	45	141.1	136.54	16	20	20
T 13099	T 14333	-	46	144.2	139.58	16	20	20
T 13100	-	-	47	147.2	142.61	16	-	-
T 13101	T 14335	T 14583	48	150.2	145.64	16	20	20
T 13102	T 14336	-	49	153.3	148.66	16	20	-
T 13103	T 14337	T 14585	50	156.3	151.69	20	20	20
T 13104	T 14338	-	51	159.3	154.72	20	20	-
T 13105	T 14339	-	52	162.4	157.75	20	20	-
T 13106	T 14340	-	53	165.4	160.78	20	20	-
T 13107	T 14341	-	54	168.4	163.82	20	20	-
T 13108	T 14342	-	55	171.4	166.85	20	20	-
T 13109	T 14343	-	56	174.5	169.88	20	20	-
T 13110	T 14344	T 14592	57	177.5	172.91	20	20	25
T 13111	T 14345	T 14593	58	180.5	175.93	20	20	25
T 13113	T 14347	T 14595	60	186.6	181.99	20	20	25
T 13114	T 14348	-	62	192.7	188.06	20	25	-
T 13116	T 14350	T 14598	64	198.7	194.12	20	25	25
T 13117	T 14351	T 14599	65	201.8	197.15	20	25	25
T 13118	-	T 14600	66	204.8	200.18	20	-	25
T 13119	T 14353	-	68	210.8	206.24	20	25	-
T 13120	T 14491	T 14602	70	216.9	212.30	20	25	25
T 13121	T 14492	T 14603	72	223.0	218.37	20	25	25
T 13122	T 14493	-	75	232.1	227.46	20	25	-
T 13123	T 14494	T 14605	76	235.1	230.49	20	25	25
-	T 65044	T 65045	78	241.2	236.55	-	25	25
T 13124	T 14495	T 14606	80	247.2	242.61	20	25	25
T 13125	T 14496	-	85	262.4	257.77	25	25	-
T 13126	T 14497	T 14608	90	277.5	272.93	25	25	25
T 13127	T 14498	T 14609	95	292.7	288.08	25	25	25
T 13128	T 14499	T 14610	100	307.8	303.25	25	25	25
T 13129	T 14500	-	110	338.2	333.55	25	25	-
T 13130	T 14501	T 14613	114	350.3	345.68	25	25	25
T 13131	T 14502	-	120	368.5	363.86	25	25	-
T 13132	T 14503	T 14614	125	383.6	379.02	25	25	25

B1	B2	B3	r3	c	b1
5.3	15.4	25.6	10	1	5.2

Rozmiary w mm.

Koło łańcuchowe bez piasty 1/2" x 1/8" (081-1)

dla łańcucha rolkowego DIN 8187/ ISO R606

Materiał

Stal C 43

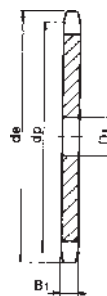

1-rzędowe

Kod	Ilość zębów z	de	dp	D1	Kod	Ilość zębów z	de	dp	D1
T 13134	9	43.4	37.13	8	T 13152	30	127.8	121.50	12
T 13135	10	47.4	41.10	8	T 08525	32	135.9	129.56	12
T 13136	11	51.4	45.07	8	T 13154	33	139.9	133.60	12
T 08522	12	55.4	49.07	8	T 13155	34	143.9	137.64	12
T 13137	13	59.4	53.06	8	T 13156	35	148.0	141.68	12
T 13138	14	63.4	57.07	8	T 13157	36	152.0	145.72	16
T 08523	15	67.4	61.09	8	T 13158	37	156.1	149.76	16
T 13139	16	71.4	65.10	8	T 13159	38	160.1	153.80	16
T 08524	17	75.4	69.11	8	T 13160	39	164.1	157.83	16
T 13140	18	79.4	73.14	8	T 13161	40	168.2	161.87	16
T 13141	19	83.5	77.16	8	T 13165	44	184.8	178.03	16
T 13142	20	87.5	81.19	8	T 13166	45	188.9	182.07	16
T 13143	21	91.5	85.22	8	T 13169	48	201.0	194.18	20
T 13144	22	95.5	89.24	10	T 13176	55	229.3	222.46	20
T 13145	23	99.6	93.27	10	T 13177	56	233.3	226.50	20
T 13146	24	103.6	97.29	12	T 13178	57	237.3	230.54	20
T 13147	25	107.6	101.33	12	T 13179	58	241.4	234.58	20
T 13148	26	111.7	105.36	12	T 13181	60	249.5	242.66	20
T 13149	27	115.7	109.40	12	T 13187	70	289.9	283.07	25
T 13150	28	119.7	113.42	12					

B1	r3	c	h
3	13	1.3	z≥31=4 z≥90=6

Rozmiary w mm.

Koło łańcuchowe bez piasty 1/2" x 3/16" (083-1/084-1)
 dla łańcucha rolkowego DIN 8187/ ISO R606

Materiał

Stal C 43

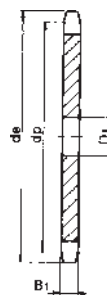

1-rzędowe

Kod	Ilość zębów z	de	dp	D1	Kod	Ilość zębów z	de	dp	D1
T 13195	9	43.4	37.13	8	T 13217	39	164.1	157.83	16
T 13196	10	47.4	41.10	8	T 13218	40	168.2	161.87	16
T 08526	11	51.4	45.07	8	T 13219	41	172.7	165.91	16
T 13197	12	55.4	49.07	8	T 13220	42	176.7	169.95	16
T 08527	13	59.4	53.06	8	T 13221	43	180.8	173.99	16
T 13198	14	63.4	57.07	8	T 13222	44	184.8	178.03	16
T 08528	15	67.4	61.09	8	T 13223	45	188.9	182.07	16
T 13199	16	71.4	65.10	8	T 13224	46	192.9	186.10	20
T 08529	17	75.4	69.11	8	T 13225	47	196.9	190.14	20
T 12468	18	79.4	73.14	8	T 13226	48	201.0	194.18	20
T 13200	19	83.5	77.16	8	T 13227	49	205.0	198.22	20
T 13201	20	87.5	81.19	8	T 13228	50	209.1	202.26	20
T 13202	21	91.5	85.22	8	T 13229	51	213.1	206.30	20
T 13203	22	95.5	89.24	10	T 13230	52	217.1	210.34	20
T 13204	23	99.6	93.27	10	T 13231	53	221.2	214.37	20
T 08530	24	103.6	97.29	12	T 13232	54	225.2	218.43	20
T 13205	25	107.6	101.33	12	T 13233	55	229.3	222.46	20
T 13206	26	111.7	105.36	12	T 13234	56	233.3	226.50	20
T 13207	27	115.7	109.40	12	T 13235	57	237.3	230.54	20
T 13208	28	119.7	113.42	12	T 13236	58	241.4	234.58	20
T 13209	29	123.8	117.46	12	T 13238	60	249.5	242.66	20
T 11263	30	127.8	121.50	12	T 13240	64	265.6	258.82	20
T 08531	31	131.8	125.54	12	T 13241	65	269.7	262.86	20
T 13210	32	135.9	129.56	12	T 13243	68	281.8	274.99	25
T 13211	33	139.9	133.60	12	T 13244	70	289.9	283.07	25
T 13212	34	143.9	137.64	12	T 13245	72	298.0	291.16	25
T 13213	35	148.0	141.68	12	T 13246	76	314.1	307.33	25
T 13214	36	152.0	145.72	16	T 13247	80	330.3	323.48	25
T 13215	37	156.1	149.76	16	T 13248	85	350.5	343.69	25
T 13216	38	160.1	153.80	16	T 65046	110	451.5	444.75	25

B1	r3	c	h
4.5	13	1.3	z≥90=6

Rozmiary w mm.

Koło łańcuchowe bez piasty 1/2" x 5/16" (08B -1 -2 -3) dla łańcucha rolkowego DIN 8187/ ISO R606

Materiał

Stal C 43

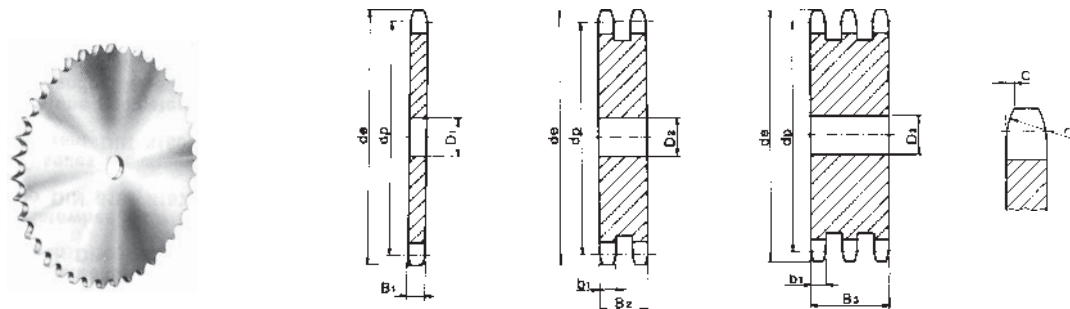

1-rzędowe	2-rzędowe	3-rzędowe	Ilość zębów z	de	dp	1-rzędowe	2-rzędowe	3-rzędowe
Kod	Kod	Kod				D1	D2	D3
T 08532	-	T 14615	8	38.0	33.18	8	-	10
T 09415	T 13298	T 14616	9	42.0	37.13	8	10	10
T 10879	T 13299	T 14617	10	45.9	41.10	8	10	10
T 13251	T 13300	T 14618	11	49.9	45.07	10	10	12
T 08533	T 13301	T 14619	12	53.9	49.07	10	10	12
T 10880	T 09002	T 14620	13	57.9	53.06	10	10	12
T 10881	T 13302	T 14621	14	61.9	57.07	10	10	12
T 08534	T 09003	T 14622	15	65.9	61.09	10	10	12
T 13252	T 13303	T 14623	16	69.9	65.10	10	12	16
T 08535	T 13304	T 14624	17	74.0	69.11	10	12	16
T 08536	T 13305	T 14625	18	78.0	73.14	10	12	16
T 13253	T 13306	T 14626	19	82.0	77.16	10	12	16
T 08537	T 13307	T 14627	20	86.0	81.19	10	12	16
T 10882	T 18424	T 14628	21	90.1	85.22	12	16	16
T 13254	T 13309	T 14629	22	94.1	89.24	12	16	16
T 11264	T 13310	T 14630	23	98.1	93.27	12	16	16
T 08538	T 13311	T 14631	24	102.1	97.29	12	16	16
T 13255	T 13312	T 14632	25	106.2	101.33	12	16	16
T 10883	T 13313	T 14633	26	110.2	105.36	16	16	16
T 08539	T 13314	T 14634	27	114.2	109.40	16	16	16
T 09892	T 13315	T 14635	28	118.3	113.42	16	16	16
T 13256	T 13316	T 14636	29	122.3	117.46	16	16	16
T 10884	T 13317	T 14637	30	126.3	121.50	16	16	16
T 11265	T 13318	-	31	130.4	125.54	16	16	-
T 08540	T 13319	T 14639	32	134.4	129.56	16	16	20
T 10885	T 13320	T 14640	33	138.4	133.60	16	16	20
T 13257	T 13321	T 14641	34	142.5	137.64	16	16	20
T 08541	T 13322	T 14642	35	146.5	141.68	16	16	20
T 13258	T 13323	T 14643	36	150.6	145.72	16	20	20
T 13259	T 13324	-	37	154.6	149.76	16	20	-
T 11266	T 09559	T 14645	38	158.6	153.80	16	20	20
T 13260	T 13325	-	39	162.7	157.83	16	20	-
T 10886	T 13326	T 14647	40	166.7	161.87	16	20	20
T 13261	T 13327	-	41	172.4	165.91	20	20	-
T 09365	T 13328	T 14649	42	176.5	169.95	20	20	25
T 13262	T 13329	T 14650	43	180.5	173.99	20	20	25

B1	B2	B3	r3	c	b1
7.2	21	34.9	13	1.3	7

Rozmiary w mm.

Koło łańcuchowe bez piasty 1/2"x5/16" (08B -1 -2 -3) dla łańcucha rolkowego DIN 8187/ ISO R606

Material

Stal C 43

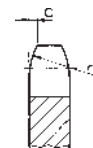
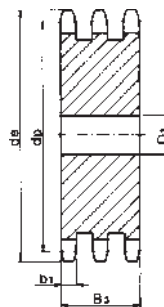
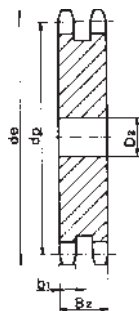
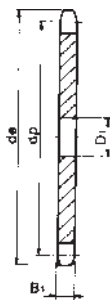

1-rzędowe	2-rzędowe	3-rzędowe	Ilość zębów z	de	dp	1-rzędowe	2-rzędowe	3-rzędowe
Kod	Kod	Kod				D1	D2	D3
T 13263	T 13330	T 14651	44	184.6	178.03	20	20	25
T 13264	T 09005	T 14652	45	188.6	182.07	20	20	25
T 13265	T 13331	T 14653	46	192.6	186.10	20	20	25
T 13266	-	T 14654	47	196.7	190.14	20	-	25
T 13267	T 13333	T 14655	48	200.7	194.18	20	20	25
T 13268	T 13334	T 14656	49	204.8	198.22	20	20	25
T 13269	T 13335	T 14657	50	208.8	202.26	20	20	25
T 13270	T 13336	-	51	212.8	206.30	20	25	-
T 13271	T 09010	T 14659	52	216.9	210.34	20	25	25
T 13272	T 13337	T 14660	53	220.9	214.37	20	25	25
T 13273	T 09011	T 14661	54	225.0	218.43	20	25	25
T 13274	T 13338	T 14662	55	229.0	222.46	20	25	25
T 13275	T 13339	T 14663	56	233.0	226.50	20	25	25
T 13276	T 13340	T 14664	57	237.1	230.54	20	25	25
T 13277	T 13341	-	58	241.1	234.58	20	25	-
T 13279	T 13343	T 14667	60	249.2	242.66	20	25	25
T 13280	T 13344	T 14668	62	257.3	250.75	25	25	25
T 13281	T 13345	-	64	265.4	258.82	25	25	-
T 13282	T 13346	T 14670	65	269.4	262.86	25	25	25
T 13283	-	-	66	273.4	266.90	25	-	-
T 13284	T 13348	T 14672	68	281.5	274.99	25	25	25
T 13285	T 13349	T 14673	70	289.6	283.07	25	25	25
T 13286	T 13351	T 14674	72	297.7	291.16	25	25	25
T 13287	T 13352	T 14675	75	309.8	303.27	25	25	25
T 13288	T 13353	T 14676	76	313.9	307.33	25	25	25
T 13289	-	-	78	321.9	315.40	25	-	25
T 13290	T 13355	T 14678	80	330.0	323.48	25	25	25
T 13291	T 13356	T 14679	85	350.2	343.69	25	25	25
T 13292	T 13357	T 14680	90	370.4	363.90	25	25	25
T 13293	T 13358	T 14681	95	390.7	384.11	25	25	25
T 13294	T 13359	T 14682	100	410.9	404.31	25	25	25
T 65047	T 65049	-	110	451.3	444.74	25	25	25
T 13295	T 13360	T 14683	114	467.4	460.90	25	25	25
T 65048	T 65050	-	120	491.7	485.16	25	25	-
T 13296	T 12185	T 14684	125	511.0	505.37	25	25	25

B1	B2	B3	r3	c	b1
7.2	21	34.9	13	1.3	7

Rozmiary w mm.

Koło łańcuchowe bez piasty 5/8"x3/8" (10B -1 -2 -3) dla łańcucha rolkowego DIN 8187/ ISO R606

Materiał

Stal C 43

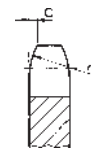
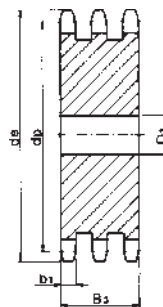
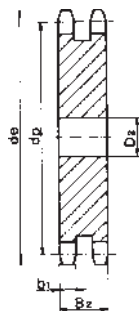
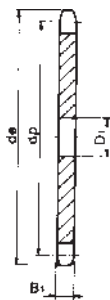

1-rzędowe	2-rzędowe	3-rzędowe	Ilość zębów z	de	dp	1-rzędowe	2-rzędowe	3-rzędowe
Kod	Kod	Kod				D1	D2	D3
T 13361	T 14685	T 14756	8	48.4	41.48	10	10	12
T 13362	T 14686	T 14757	9	53.3	46.42	10	10	12
T 10701	-	-	10	58.3	51.37	10	-	-
T 13363	T 14688	-	11	63.2	56.34	10	10	-
T 08542	T 14689	-	12	68.2	61.34	10	10	-
T 13364	T 14690	T 14761	13	73.2	66.32	10	10	12
T 13365	T 14691	T 14762	14	78.2	71.34	12	10	12
T 08543	T 14692	T 14763	15	83.2	76.36	12	12	12
T 09355	T 14693	T 14764	16	88.3	81.37	12	12	16
T 08544	T 14694	T 14765	17	93.3	86.39	12	12	16
T 13366	T 14695	T 14766	18	98.3	91.42	12	12	16
T 08545	T 14696	T 14767	19	103.3	96.45	12	12	16
T 13367	T 14697	T 14768	20	108.4	101.49	12	12	16
T 13368	T 18425	T 14769	21	113.4	106.52	12	16	16
T 08546	T 14699	T 14770	22	118.4	111.55	12	16	16
T 13369	T 14700	T 14771	23	123.5	116.58	12	16	16
T 13370	T 14701	T 14772	24	128.5	121.62	12	16	16
T 13371	T 14702	T 14773	25	133.6	126.66	12	16	16
T 13372	T 14703	T 14774	26	138.6	131.70	16	20	20
T 13373	T 14704	T 14775	27	143.6	136.75	16	20	20
T 08547	T 14705	T 14776	28	148.7	141.78	16	20	20
T 13374	T 14706	T 14777	29	153.7	146.83	16	20	20
T 13375	T 14707	T 14778	30	158.8	151.87	16	20	20
T 13376	T 14708	-	31	163.8	156.92	16	20	-
T 13377	T 14709	T 14780	32	168.9	161.95	16	20	20
T 11267	T 14710	T 14781	33	173.9	167.00	16	20	20
T 13378	T 14711	T 14782	34	178.9	172.05	16	20	20
T 11268	T 14712	T 14783	35	184.0	177.10	16	20	20
T 13379	T 14713	T 14784	36	189.0	182.15	20	20	25
T 13380	T 14714	T 14785	37	194.1	187.20	20	20	25
T 13381	T 14715	T 14786	38	199.1	192.24	20	20	25
T 13382	T 14716	T 14787	39	204.2	197.29	20	20	25
T 13383	T 14717	T 14788	40	209.2	202.34	20	20	25
T 13384	-	T 14789	41	215.8	207.39	20	-	25
T 13385	T 14719	T 14790	42	220.8	212.44	20	25	25
T 13386	T 14720	-	43	225.9	217.49	20	25	-

B1	B2	B3	r3	c	b1
9.1	25.5	42.1	16	1.6	9

Rozmiary w mm.

Koło łańcuchowe bez piasty 5/8" x 3/8" (10B -1 -2 -3) dla łańcucha rolkowego DIN 8187/ ISO R606

Materiał

Stal C 43

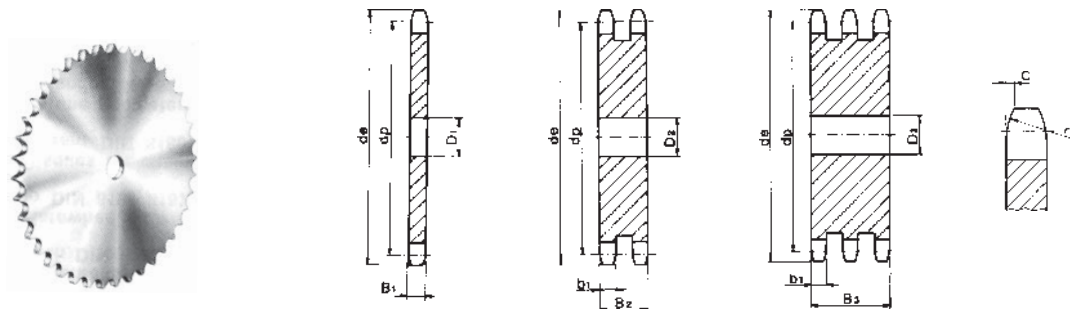

1-rzędowe	2-rzędowe	3-rzędowe	Ilość zębów z	de	dp	1-rzędowe	2-rzędowe	3-rzędowe
Kod	Kod	Kod				D1	D2	D3
T 13387	T 14721	T 14792	44	230.9	222.53	20	25	25
T 13388	T 14722	T 14793	45	236.0	227.58	20	25	25
T 13389	T 14723	T 14794	46	241.0	232.63	20	25	25
T 13390	T 14724	-	47	246.1	237.68	20	25	25
T 13391	T 14725	T 14796	48	251.1	242.73	20	25	25
T 13392	-	-	49	256.2	247.78	20	-	-
T 13393	T 14727	T 14798	50	261.2	252.82	20	25	25
T 13394	-	-	51	266.3	257.87	20	-	-
T 13395	T 14729	T 14800	52	271.3	262.92	20	25	25
T 13396	T 14730	-	53	276.4	267.97	20	25	-
T 13397	T 14731	-	54	281.4	273.03	20	25	-
T 13398	T 14732	T 14803	55	286.5	278.08	20	25	25
T 13399	T 14733	-	56	291.5	283.13	25	25	-
T 13400	T 14734	T 14805	57	296.6	288.18	25	25	25
T 13401	T 14735	-	58	301.6	293.23	25	25	-
T 13403	T 14737	T 14808	60	311.7	303.32	25	25	25
T 13404	T 14738	-	62	321.8	313.43	25	25	-
T 13406	-	T 14811	64	331.9	323.53	25	-	30
T 13407	T 14741	T 14812	65	337.0	328.58	25	25	30
-	T 14742	-	66	342.0	333.63	-	25	-
T 13409	-	-	68	352.1	343.74	25	-	-
T 13410	T 14744	T 14815	70	362.2	353.84	25	25	30
T 13411	T 14745	-	72	372.3	363.95	25	25	-
T 13412	T 14746	T 14817	75	387.5	379.09	25	25	30
T 13413	T 14747	T 14818	76	392.5	384.16	25	25	30
T 13414	-	-	78	402.6	394.25	25	-	-
T 13415	T 14749	T 14820	80	412.7	404.35	25	25	30
T 13416	T 14750	-	85	438.0	429.62	30	30	-
T 13417	T 14751	T 14822	90	463.3	454.88	30	30	30
T 13418	T 14752	T 14823	95	488.5	480.14	30	30	30
T 13419	T 14753	-	100	513.8	505.40	30	30	-
T 65053	-	-	110	564.3	555.92	30	-	-
T 13420	T 14754	T 14825	114	584.5	576.13	30	30	30
T 65054	T 65055	-	120	614.8	606.44	30	30	-
T 13421	T 14755	T 14826	125	640.1	631.71	30	30	30

B1	B2	B3	r3	c	b1
9.1	25.5	42.1	16	1.6	9

Rozmiary w mm.

Koło łańcuchowe bez piasty 3/4"x7/16" (12B -1 -2 -3) dla łańcucha rolkowego DIN 8187/ ISO R606

Materiał

Stal C 43

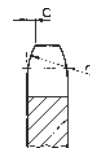
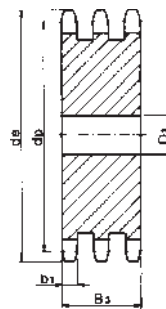
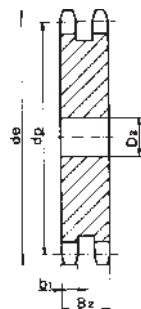
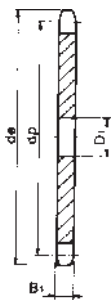

1-rzędowe	2-rzędowe	3-rzędowe	Ilość zębów z	de	dp	1-rzędowe	2-rzędowe	3-rzędowe
Kod	Kod	Kod				D1	D2	D3
T 13422	T 13483	-	8	58.0	49.78	10	12	-
T 13423	-	T 14828	9	63.9	55.70	10	-	12
T 08635	-	-	10	69.8	61.64	10	-	-
T 13424	T 13486	T 14830	11	75.8	67.61	12	12	16
T 08636	T 13487	T 14831	12	81.8	73.50	14	14	16
T 13425	T 13488	T 14832	13	87.8	79.59	14	14	16
T 13426	T 13489	T 14833	14	93.8	85.61	14	16	16
T 08637	T 13490	T 14834	15	99.8	91.63	14	16	16
T 13427	T 13491	T 14835	16	105.8	97.65	14	16	20
T 08638	T 13492	T 14836	17	111.9	103.67	14	16	20
T 13428	T 13493	T 14837	18	117.9	109.71	14	16	20
T 08639	T 13494	T 14838	19	123.9	115.75	14	16	20
T 13429	T 11734	T 14839	20	130.0	121.78	14	16	20
T 13430	T 18426	T 14840	21	136.0	127.82	16	20	20
T 08640	T 13496	T 14841	22	142.0	133.86	16	20	20
T 13431	T 13497	T 14842	23	148.1	139.90	16	20	20
T 08641	T 13498	T 14843	24	154.1	145.94	16	20	20
T 13433	T 13499	T 14844	25	160.2	152.00	16	20	20
T 13434	T 13500	T 14845	26	166.2	158.04	16	20	20
T 13435	T 13501	T 14846	27	172.3	164.09	16	20	20
T 13436	T 13502	T 14847	28	178.3	170.13	16	20	20
T 13437	T 13503	T 14848	29	184.4	176.19	16	20	20
T 13438	T 13504	T 14849	30	190.4	182.25	16	20	20
T 08642	T 13505	T 14850	31	196.5	188.31	20	20	25
T 13439	T 13506	T 14851	32	202.5	194.35	20	20	25
T 13440	T 13507	T 14852	33	208.6	200.40	20	20	25
T 13441	T 13508	T 14853	34	214.6	206.46	20	20	25
T 13442	T 13509	T 14854	35	220.7	212.52	20	20	25
T 13443	T 13510	T 14855	36	226.8	218.58	20	25	25
T 13444	T 13511	T 14856	37	232.8	224.64	20	25	25
T 13445	T 13512	T 14857	38	238.9	230.69	20	25	25
T 13446	T 13513	T 14858	39	244.9	236.75	20	25	25
T 13447	T 13514	T 14859	40	251.0	242.81	20	25	25
T 13448	T 13515	-	41	258.9	248.87	25	25	-
T 13449	T 13516	T 14861	42	265.0	254.93	25	25	25
T 13450	T 13517	T 14862	43	271.1	260.98	25	25	25

B1	B2	B3	r3	c	b1
11.1	30.3	49.8	19	2	10.8

Rozmiary w mm.

Koło łańcuchowe bez piasty 3/4" x 7/16" (12B -1 -2 -3) dla łańcucha rolkowego DIN 8187/ ISO R606

Materiał

Stal C 43

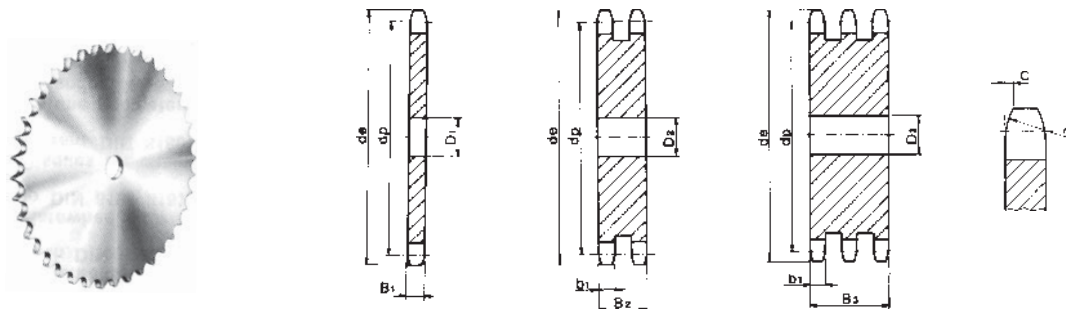

1-rzędowe	2-rzędowe	3-rzędowe	Ilość zębów z	de	dp	1-rzędowe	2-rzędowe	3-rzędowe
Kod	Kod	Kod				D1	D2	D3
T 13451	T 13518	T 14863	44	277.1	267.03	25	25	25
T 13452	T 13519	T 14864	45	283.2	273.10	25	25	25
T 13453	T 13520	-	46	289.2	279.16	25	25	-
T 13454	T 13521	T 14866	47	295.3	285.21	25	25	25
T 13455	T 13522	T 14867	48	301.4	291.27	25	25	25
T 13456	-	-	49	307.4	297.33	25	-	-
T 13457	T 13524	T 14869	50	313.5	303.39	25	25	25
T 13458	-	-	51	319.5	309.45	25	-	-
T 13459	T 13526	T 14871	52	325.6	315.50	25	25	25
T 13460	-	-	53	331.6	321.56	25	-	-
T 13461	T 13528	T 14873	54	337.7	327.64	25	25	25
T 13462	T 13529	T 14874	55	343.8	333.70	25	25	25
T 13463	T 13530	-	56	349.8	339.75	25	25	-
T 13464	T 13531	T 14876	57	355.9	345.81	25	25	30
T 13465	T 13532	-	58	362.0	351.87	25	25	30
T 13467	T 13534	T 14879	60	374.1	363.99	25	25	30
T 13468	-	-	62	386.2	376.12	25	-	-
T 11223	T 13536	-	64	398.3	388.24	25	30	-
T 13469	T 13537	T 14882	65	404.4	394.29	25	30	30
-	-	-	66	410.1	400.35	-	-	30
T 13471	-	-	68	422.6	412.49	30	-	-
T 13472	T 13540	T 14885	70	434.7	424.60	30	30	30
T 13473	T 13541	T 14886	72	446.8	436.74	30	30	30
T 13474	T 13542	-	75	465.0	454.91	30	30	-
T 13475	T 13543	T 14888	76	471.1	460.99	30	30	30
T 65056	-	-	78	483.2	473.10	30	-	-
T 13476	T 13544	T 14889	80	495.3	485.22	30	30	30
T 13477	T 13545	T 14890	85	525.6	515.55	30	30	30
T 13478	T 13546	T 14891	90	555.9	545.86	30	30	30
T 13479	T 13547	T 14892	95	586.2	576.17	30	30	30
T 13480	T 13548	T 14893	100	616.6	606.47	30	30	30
T 65057	-	-	110	677.2	667.11	30	-	-
T 13481	T 13549	T 14894	114	701.4	691.36	30	30	30
T 65058	-	T 65059	120	737.8	727.74	30	-	30
T 13482	T 13550	T 14895	125	768.1	758.05	30	30	30

B1	B2	B3	r3	c	b1
11.1	30.3	49.8	19	2	10.8

Rozmiary w mm.

Koło łańcuchowe bez piasty 1"x17.02mm(16B -1 -2 -3) dla łańcucha rolkowego DIN 8187/ ISO R606

Materiał

Stal C 43

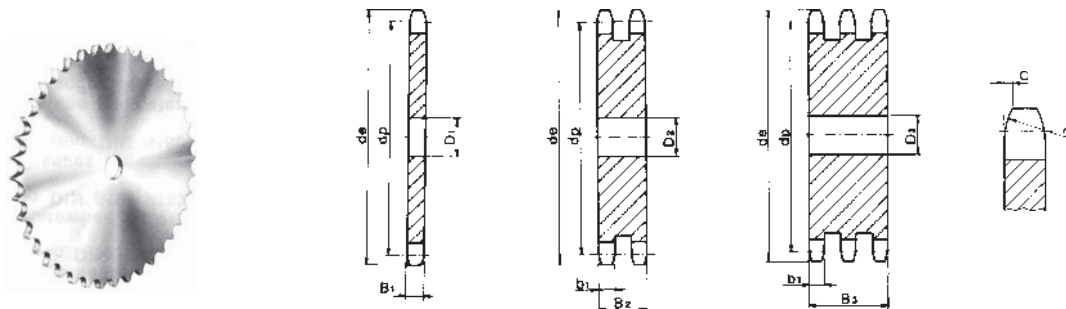

1-rzędowe	2-rzędowe	3-rzędowe	Ilość zębów z	de	dp	1-rzędowe	2-rzędowe	3-rzędowe
Kod	Kod	Kod				D1	D2	D3
T 14896	T 14963	T 15031	8	77.9	66.37	16	16	16
T 14897	T 14964	T 15032	9	85.8	74.27	16	16	16
T 14898	T 14965	T 15033	10	93.8	82.19	16	16	16
T 14899	T 14966	T 15034	11	101.7	90.14	16	20	20
T 14900	T 14967	T 15035	12	109.7	98.14	16	20	20
T 14901	T 14968	T 15036	13	117.7	106.12	16	20	20
T 14902	T 14969	T 15037	14	125.7	114.15	16	20	20
T 14903	T 14970	T 15038	15	133.7	122.17	16	20	20
T 14904	T 14971	T 15039	16	141.8	130.20	20	20	25
T 14905	T 14972	T 15040	17	149.8	138.22	20	20	25
T 14906	T 14973	T 15041	18	157.8	146.28	20	20	25
T 14907	T 14974	T 15042	19	165.9	154.33	20	20	25
T 14908	T 14975	T 15043	20	173.9	162.38	20	20	25
T 14909	T 18427	T 15044	21	182.0	170.43	20	25	25
T 14910	T 14977	T 15045	22	190.1	178.48	20	25	25
T 14911	T 14978	T 15046	23	198.1	186.53	20	25	25
T 14912	T 14979	T 15047	24	206.2	194.59	20	25	25
T 14913	T 14980	T 15048	25	214.2	202.66	20	25	25
T 14914	T 14981	T 15049	26	222.3	210.72	20	25	30
T 14915	T 14982	T 15050	27	230.4	218.79	20	25	30
T 14916	T 14983	T 15051	28	238.4	226.85	20	25	30
T 14917	T 14984	T 15052	29	246.5	234.92	20	25	30
T 14918	T 14985	T 15053	30	254.6	243.00	20	25	30
T 14919	T 14986	T 15054	31	262.6	251.08	25	25	30
T 14920	T 14987	T 15055	32	270.7	259.13	25	25	30
T 14921	T 14988	T 15056	33	278.8	267.21	25	25	30
T 14922	T 14989	T 15057	34	286.9	275.28	25	25	30
T 14923	T 14990	T 15058	35	294.9	283.36	25	25	30
T 14924	T 14991	T 15059	36	303.0	291.44	25	25	30
T 14925	T 14992	-	37	311.1	299.51	25	25	-
T 14926	T 14993	T 15061	38	319.2	307.59	25	25	30
T 14927	T 14994	-	39	327.2	315.67	25	25	-
T 14928	T 14995	T 15063	40	335.3	323.73	25	25	30
T 14929	-	-	41	345.6	331.82	25	-	-
T 14930	T 14997	T 15065	42	353.7	339.90	25	25	30

B1	B2	B3	r3	c	b1
16.2	47.7	79.6	26	2.5	15.8

Rozmiary w mm.

Koło łańcuchowe bez piasty 1"x17.02 mm(16B -1 -2 -3) dla łańcucha rolkowego DIN 8187/ ISO R606

Materiał

Stal C 43

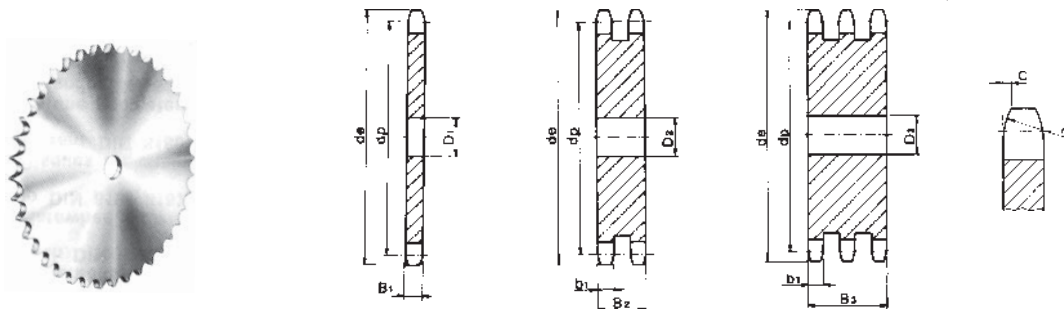

1-rzędowe	2-rzędowe	3-rzędowe	Ilość zębów z	de	dp	1-rzędowe	2-rzędowe	3-rzędowe
Kod	Kod	Kod				D1	D2	D3
T 14931	T 14998	-	43	361.7	347.98	25	25	-
T 14932	T 14999	T 15067	44	369.8	356.06	25	25	30
T 14933	T 15000	T 15068	45	377.9	364.13	25	25	30
T 14934	T 15002	-	46	386.0	372.21	25	25	30
T 14935	-	-	47	394.1	380.29	25	-	-
T 14936	T 15004	T 15071	48	402.1	388.36	25	25	30
T 14937	-	-	49	410.2	396.44	25	-	-
T 14938	T 15006	T 15073	50	418.3	404.52	25	25	30
T 14939	-	-	51	426.4	412.60	30	-	-
T 14940	T 15008	T 15075	52	434.5	420.67	30	30	40
T 14941	-	-	53	442.5	428.75	30	-	-
T 14942	-	-	54	450.6	436.85	30	-	-
T 14943	T 15011	T 15078	55	458.7	444.93	30	30	40
T 14944	T 15012	-	56	466.8	453.01	30	40	40
T 14945	T 15013	T 15080	57	474.9	461.07	30	40	40
T 14946	-	-	58	482.9	469.16	30	-	-
T 14948	T 15016	T 15083	60	499.1	485.32	30	40	40
T 14949	T 15017	-	62	515.3	501.50	30	40	-
T 14950	-	-	64	531.4	517.65	30	-	-
T 14951	T 15019	T 15086	65	539.5	525.73	30	40	40
T 14954	T 15022	-	68	563.8	549.98	30	40	-
T 14955	T 15023	T 15090	70	579.9	566.14	30	40	40
T 14956	T 15024	T 15091	72	596.1	582.32	30	40	40
T 14957	T 15025	-	75	620.3	606.55	30	40	-
T 14958	T 15026	T 15093	76	628.4	614.65	30	40	40
T 65060	-	-	78	644.6	630.80	30	-	-
T 14959	T 15027	T 15094	80	660.7	646.96	30	40	40
T 65061	T 65066	T 65069	85	701.2	687.40	30	40	40
T 65062	T 65067	T 65070	90	741.6	727.82	30	40	40
T 14960	T 15028	T 15095	95	782.0	768.22	30	40	40
T 65063	T 65068	-	100	822.4	808.63	30	40	-
T 65064	-	-	110	903.3	889.48	30	-	-
T 14961	T 15029	T 15096	114	935.6	921.82	30	40	40
T 65065	-	-	120	984.1	970.33	30	-	-
T 14962	T 15030	T 15097	125	1024.5	1010.73	30	40	40

B1	B2	B3	r3	c	b1
16.2	47.7	79.6	26	2.5	15.8

Rozmiary w mm.

Koło łańcuchowe bez piasty 1 1/4" x 3/4" (20B -1 -2 -3) dla łańcucha rolkowego DIN 8187/ ISO R606

Materiał

Stal C 43

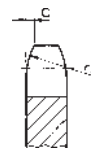
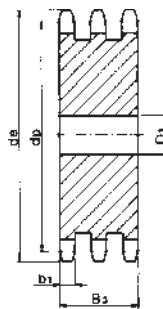
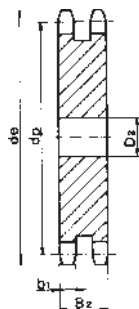
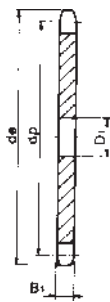

1-rzędowe	2-rzędowe	3-rzędowe	Ilość zębów z	de	dp	1-rzędowe	2-rzędowe	3-rzędowe
Kod	Kod	Kod				D1	D2	D3
T 13551	T 15098	T 15168	8	96.0	82.96	16	20	20
T 13552	T 15099	T 15169	9	106.5	92.84	16	20	20
T 13553	T 15100	T 15170	10	117.0	102.74	16	20	20
T 13554	T 15101	T 15171	11	127.0	112.68	20	20	25
T 08648	T 15102	T 15172	12	137.0	122.68	20	20	25
T 13555	T 15103	T 15173	13	147.5	132.65	20	20	25
T 13556	T 15104	T 15174	14	157.6	142.68	20	20	25
T 13557	T 15105	T 15175	15	167.7	152.72	20	20	25
T 13558	T 15106	T 15176	16	177.7	162.75	20	30	30
T 13559	T 15107	T 15177	17	187.7	172.78	20	30	30
T 13560	T 15108	T 15178	18	197.8	182.85	20	30	30
T 13561	T 15109	T 15179	19	207.9	192.91	20	30	30
T 13562	T 15110	T 15180	20	217.9	202.98	20	30	30
T 13563	-	T 15181	21	228.0	213.04	25	30	30
T 08649	T 15112	T 15182	22	238.1	223.11	25	30	30
T 13564	T 15113	T 15183	23	248.2	233.17	25	30	30
T 13565	T 15114	T 15184	24	258.3	243.23	25	30	30
T 13566	T 15115	T 15185	25	268.4	253.33	25	30	30
T 13567	T 15116	T 15186	26	278.4	263.40	30	30	30
T 13568	T 15117	T 15187	27	288.5	273.48	30	30	30
T 13569	T 15118	T 15188	28	298.5	283.56	30	30	30
T 13570	T 15119	-	29	308.6	293.65	30	30	-
T 13571	T 15120	T 15190	30	318.7	303.75	30	30	30
T 13572	T 15121	-	31	328.8	313.85	30	30	-
T 13573	T 15122	T 15192	32	338.9	323.91	30	30	30
T 13574	-	-	33	349.0	334.01	30	-	30
T 13575	T 15124	T 15194	34	359.1	344.10	30	30	30
T 13576	T 15125	T 15195	35	369.2	354.20	30	30	30
T 13577	T 15126	T 15196	36	379.2	364.30	30	30	30
T 13578	-	-	37	389.3	374.39	30	-	-

B1	B2	B3	r3	c	b1
18.5	54.6	91	32	3.5	18.2

Rozmiary w mm.

Koło łańcuchowe bez piasty 1 1/4" x 3/4" (20B -1 -2 -3) dla łańcucha rolkowego DIN 8187/ ISO R606

Materiał

Stal C 43

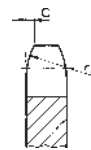
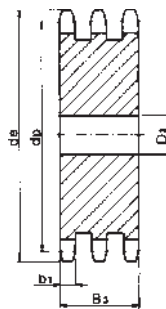
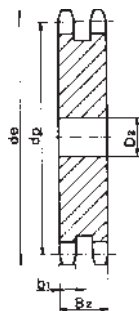
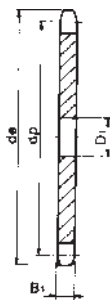

1-rzędowe	2-rzędowe	3-rzędowe	Ilość zębów z	de	dp	1-rzędowe	2-rzędowe	3-rzędowe
Kod	Kod	Kod				D1	D2	D3
T 13579	T 15128	T 15198	38	399.4	384.49	30	30	30
T 13580	-	-	39	409.5	394.59	30	-	-
T 13581	T 15130	T 15200	40	419.6	404.66	30	30	30
T 13582	-	-	41	430.7	414.78	30	-	-
T 13583	T 15132	-	42	440.8	424.88	30	30	-
T 13584	-	-	43	450.9	434.97	30	-	-
T 13585	-	-	44	461.0	445.07	30	-	-
T 13586	T 15139	T 15205	45	471.1	455.17	30	30	40
T 13587	T 15140	-	46	481.2	465.26	30	30	-
T 13589	T 15142	-	48	501.4	485.46	30	30	-
T 13591	T 15144	T 15210	50	521.6	505.65	30	30	40
T 13593	T 15146	-	52	541.8	525.84	30	40	-
T 13595	-	-	54	562.0	546.07	30	-	-
T 13596	-	T 15215	55	572.1	556.16	30	-	40
T 13597	-	-	56	582.2	566.26	30	-	-
T 13598	T 15151	T 15217	57	592.3	576.36	30	40	40
T 13599	-	-	58	602.4	586.45	30	-	-
T 13601	T 15154	T 15221	60	622.6	606.65	30	40	40
T 13603	-	-	64	663.0	647.06	30	-	-
T 13604	T 15157	T 15224	65	673.1	657.16	30	40	40
T 13607	T 15160	T 15227	70	723.6	707.67	30	40	40
T 13609	-	-	75	774.2	758.19	30	-	-
T 13610	T 15163	T 15229	76	784.3	768.32	30	40	40
T 13611	T 15164	-	80	824.7	808.72	30	40	-
T 65071	-	-	85	875.2	859.25	30	-	-
T 65072	-	-	90	925.7	909.76	30	-	-
T 13612	T 15165	-	95	976.2	960.28	30	40	-
T 29388	-	-	100	1026.7	1010.79	40	-	-

B1	B2	B3	r3	c	b1
18.5	54.6	91	32	3.5	18.2

Rozmiary w mm.

Koło łańcuchowe bez piasty 1 1/2" x 1" (24B -1 -2 -3) dla łańcucha rolkowego DIN 8187/ ISO R606

Material

Stal C 43

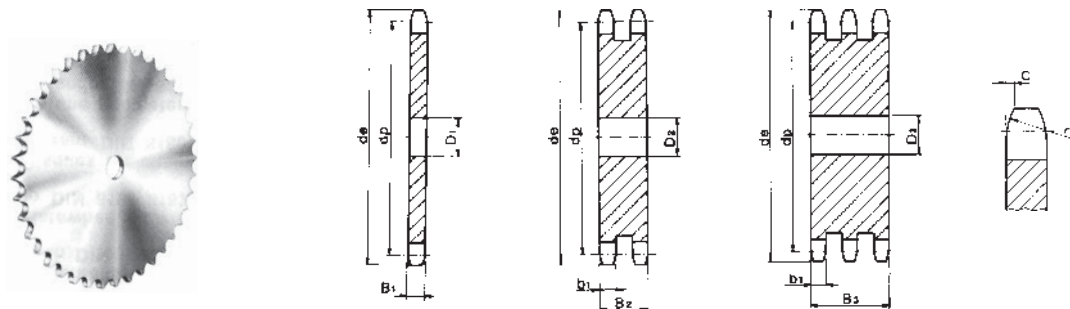

1-rzędowe	2-rzędowe	3-rzędowe	Ilość zębów z	de	dp	1-rzędowe	2-rzędowe	3-rzędowe
Kod	Kod	Kod				D1	D2	D3
T 15234	T 15298	T 15385	8	113.0	99.55	20	25	25
T 15235	T 15299	T 15386	9	125.0	111.40	20	25	25
T 15236	T 15300	T 15387	10	137.0	123.29	20	25	25
T 15237	T 15301	T 15388	11	149.0	135.21	25	25	30
T 15238	T 15302	T 15389	12	161.0	147.22	25	25	30
T 15239	T 15303	T 15390	13	173.0	159.18	25	25	30
T 15240	T 15304	T 15391	14	185.0	171.22	25	25	30
T 15241	T 15305	T 15392	15	197.0	183.26	25	25	30
T 15242	T 15306	T 15393	16	209.0	195.30	25	30	30
T 15243	T 15307	T 15394	17	221.0	207.34	25	30	30
T 15244	T 15330	T 15395	18	233.0	219.42	25	30	30
T 15245	T 15331	T 15396	19	245.5	231.49	25	30	30
T 15246	T 15332	T 15397	20	257.5	243.57	25	30	30
T 15247	T 65076	T 15398	21	270.5	255.65	30	30	40
T 15248	T 15334	T 15399	22	282.5	267.73	30	30	40
T 15249	T 15335	T 15400	23	294.5	279.80	30	30	40
T 15250	T 15336	T 15401	24	307.0	291.88	30	30	40
T 15251	T 15337	T 15402	25	319.0	304.00	30	30	40
T 15252	T 15338	T 15403	26	331.0	316.08	30	30	40
T 15253	T 15339	T 15404	27	343.0	328.19	30	30	40
T 15254	T 15340	T 15405	28	355.0	340.27	30	30	40
T 15255	T 15341	-	29	367.5	352.38	30	30	-
T 15256	T 15342	T 15407	30	379.5	364.50	30	30	40
T 15257	T 15343	-	31	391.5	376.62	30	40	-
T 15258	T 15344	T 15409	32	403.5	388.69	30	40	40
T 15259	T 15345	-	33	415.5	400.81	30	40	-

B1	B2	B3	r3	c	b1
24.1	72	120.3	38	4	23.6

Rozmiary w mm.

Koło łańcuchowe bez piasty 1 1/2" x 1" (24B -1 -2 -3) dla łańcucha rolkowego DIN 8187/ ISO R606

Materiał

Stal C 43

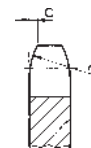
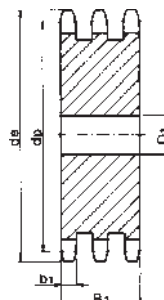
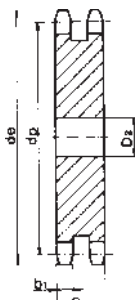
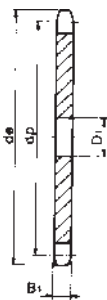

1-rzędowe	2-rzędowe	3-rzędowe	Ilość zębów z	de	dp	1-rzędowe	2-rzędowe	3-rzędowe
Kod	Kod	Kod				D1	D2	D3
T 15260	T 15346	-	34	428.0	412.93	30	40	-
T 15261	T 15347	T 15412	35	440.0	425.04	30	40	40
T 15262	T 15348	-	36	452.0	437.16	30	40	-
T 15263	T 15349	-	37	464.0	449.27	30	40	-
T 15264	T 15350	T 15415	38	476.5	461.39	30	40	40
T 15266	T 15352	T 15417	40	501.5	485.62	30	40	40
T 15267	-	-	41	513.5	497.74	30	-	-
T 15268	T 15354	-	42	525.5	509.85	30	40	-
T 15271	T 15357	T 15422	45	562.0	546.20	30	40	40
T 15272	-	-	46	574.0	558.32	30	-	-
T 15274	T 15360	T 15425	48	598.5	582.55	30	40	40
T 15276	T 15362	T 15427	50	622.5	606.78	30	40	40
T 15278	-	-	52	647.0	631.01	30	-	-
T 15280	-	-	54	671.0	655.25	30	-	-
T 15281	-	-	55	683.5	667.40	30	-	-
T 15282	-	-	56	695.5	679.50	30	-	-
T 15283	T 15369	T 15434	57	707.5	691.63	30	40	40
T 15286	T 15372	T 15437	60	745.0	727.97	30	40	40
T 15287	-	-	62	769.0	752.24	40	-	-
T 15289	T 15375	-	65	805.5	788.59	40	40	-
T 15292	-	-	70	866.0	849.21	40	-	-
T 15295	T 15382	T 15446	76	939.0	921.98	40	40	40
T 65077	-	-	80	987.5	970.44	40	-	-
T 15296	-	-	85	1048.0	1031.10	40	-	-
T 15297	T 77452	-	95	1169.0	1152.33	40	-	-

B1	B2	B3	r3	c	b1
24.1	72	120.3	38	4	23.6

Rozmiary w mm.

Koło łańcuchowe bez piasty 1 3/4"x1 1/4" (28B -1 -2 -3) dla łańcucha rolkowego DIN 8187/ ISO R606

Materiał

Stal C 43

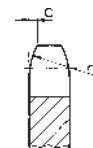
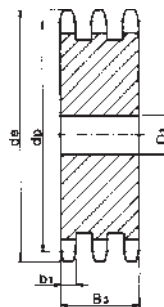
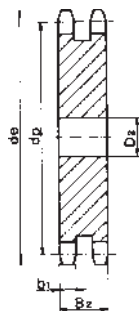
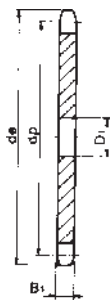

1-rzędowe	2-rzędowe	3-rzędowe	Ilość zębów z	de	dp	1-rzędowe	2-rzędowe	3-rzędowe
Kod	Kod	Kod				D1	D2	D3
Na zapytanie	Na zapytanie	Na zapytanie	8	132.0	116.15	20	25	25
			9	146.0	129.96	20	25	25
			10	160.0	143.85	20	25	25
			11	174.0	157.77	25	30	30
			12	188.0	171.74	25	30	30
			13	204.0	185.75	25	30	30
			14	218.0	199.76	25	30	30
			15	232.0	213.79	25	30	30
			16	246.0	227.84	30	30	30
			17	260.0	241.90	30	30	30
			18	274.0	255.98	30	30	30
			19	289.0	270.06	30	30	30
			20	303.0	284.15	30	30	30
			21	317.0	298.24	30	30	40
			22	331.0	312.34	30	30	-
			23	345.0	326.44	30	30	40
			24	359.0	340.55	30	30	-
			25	373.0	354.66	30	30	40
			26	387.0	368.77	30	40	-
			27	401.0	382.88	30	-	-
			28	416.0	397.00	30	40	-
			30	444.0	425.24	30	40	40
			32	472.0	453.49	30	-	-
			34	500.0	481.75	30	-	-
			35	514.0	495.88	30	40	-
			36	529.0	510.01	30	-	-
			38	557.0	538.27	30	40	40
			40	585.0	566.54	30	40	40
45	656.0	637.22	30	40	-			
50	726.0	707.91	30	40	-			
57	825.0	806.90	40	40	40			
60	869.0	849.32	40	-	-			
76	1095.0	1075.62	40	40	40			

B1	B2	B3	r3	c	b1
29.4	88.4	148	44	5	28.8

Rozmiary w mm.

Koło łańcuchowe bez piasty 2" x 1 1/4" (32B -1 -2 -3) dla łańcucha rolkowego DIN 8187/ ISO R606

Materiał

Stal C 43

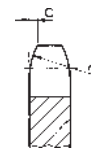
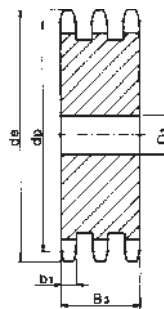
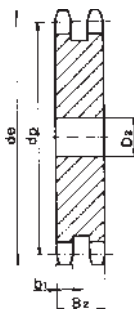
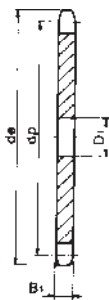

1-rzędowe	2-rzędowe	3-rzędowe	Ilość zębów z	de	dp	1-rzędowe	2-rzędowe	3-rzędowe
Kod	Kod	Kod				D1	D2	D3
Na zapytanie	Na zapytanie	Na zapytanie	8	152.0	132.74	25	25	25
			9	168.0	148.54	25	25	25
			10	184.0	164.39	25	25	25
			11	200.0	180.31	30	35	35
			12	216.0	196.29	30	35	35
			13	235.0	212.29	30	35	35
			14	251.0	228.29	30	35	35
			15	267.0	244.30	30	35	35
			16	283.0	260.40	30	40	40
			17	299.0	276.46	30	40	40
			18	315.0	292.55	30	40	40
			19	331.0	308.66	30	40	40
			20	347.0	324.71	40	40	40
			21	363.0	340.82	40	40	40
			22	379.0	356.98	40	40	-
			23	396.0	373.08	40	40	40
			24	412.0	389.18	40	40	-
			25	428.0	405.33	40	40	40
			26	444.0	421.44	40	40	-
			28	476.0	453.69	40	40	-
			30	508.0	486.00	40	40	40
			32	541.0	518.27	40	-	-
			35	589.0	566.71	40	40	40
			38	638.0	615.16	40	40	40
			40	670.0	647.47	40	40	-
			45	751.0	728.24	40	40	40
50	832.0	809.04	40	40	40			
57	945.0	922.16	40	40	40			
60	993.0	970.65	40	-	-			
76	1252.0	1229.27	40	40	40			

B1	B2	B3	r3	c	b1
29.4	87.4	146	51	6	28.8

Rozmiary w mm.